



GUARD DOG®

LOW PROFILE PROTECTORS

HEAVY DUTY LOW PROFILE 1 CHANNEL SYSTEM WITH STANDARD RAMPS

ASSEMBLY INSTRUCTIONS

ASSEMBLY:

- Inspect areas for safety hazards
- Assemble sections by aligning female connectors over male connectors
- Press with foot to secure female connectors to male connectors
- Open cover and install cables down into channels
- Close cover flush with base
- Test installation for intended use
- Periodically inspect installation

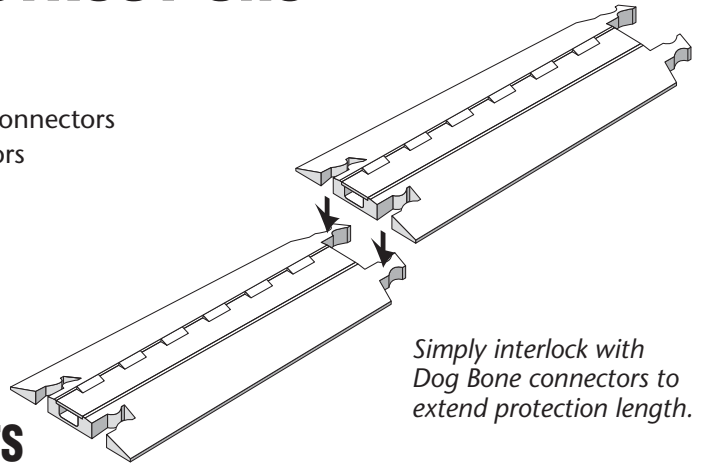

CABLE/HOSE MANAGEMENT COMPONENTS

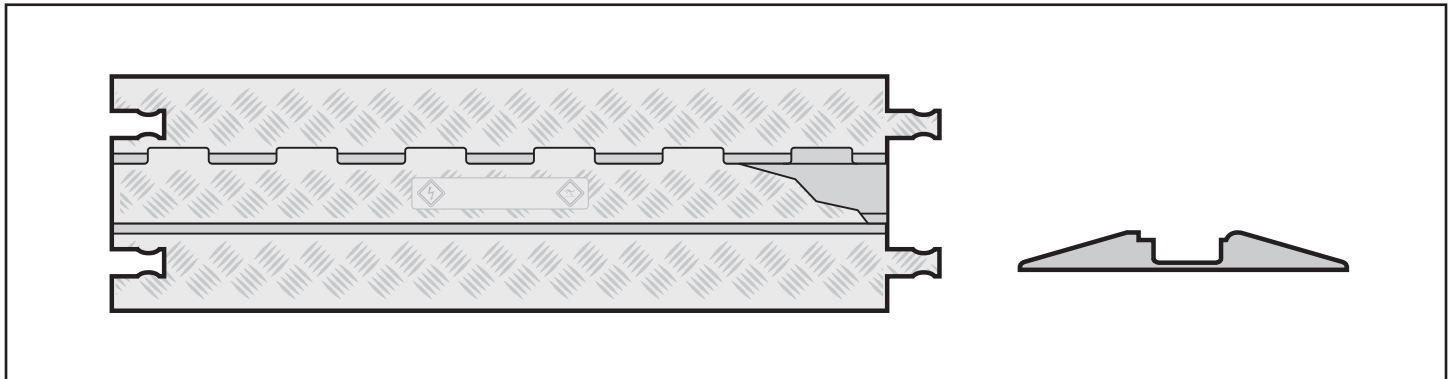

CHANNEL CAPACITY:

CHANNEL CAPACITY - MAX. DIAMETER INCHES (mm)	
1 Channel	2.25 in. (57.2 mm) width x .75 in. (19.0 mm) height

LOAD CAPACITY:

The Cable/Hose Protection System has different load supporting capabilities depending on type of vehicle and temperature. Suitability must be verified by testing under actual conditions.

NO. OF CHANNELS	LOAD CAPACITY PER TIRE MAX LOAD 70°F (21°C)	LOAD CAPACITY PER AXLE MAX LOAD 70°F (21°C)
1 Channel	13,000 lbs./Tire (5,896 kg)	26,000 lbs./Axle (11,792 kg)

OPERATING TEMPERATURE:

-40°F to 120°F (-40°C to 48°C)

CHEMICAL RESISTANCE:

Tested for compatibility with common motor oils, gasoline and diesel fuel. Limited resistance to brake fluids and other chemicals.

MATERIAL:

UV-stabilized polyurethane elastomer



GUARD DOG®

LOW PROFILE PROTECTORS

HEAVY DUTY LOW PROFILE 1 CHANNEL SYSTEM WITH STANDARD RAMPS

CABLE AND HOSE MANAGEMENT SYSTEM INSTALLATION INSTRUCTIONS

GUARD DOG® is a cable/hose management system intended to reduce the possibility of damage to cables and hose lines that are subject to pedestrian and vehicular traffic. It is intended for temporary installations only and must be in accordance with all applicable electrical, building and safety codes. DO NOT use connectors or splices within this system.

CAUTION: MISUSE CAN CAUSE ELECTRICAL SHOCK AND INJURY

- DO NOT use as work surface. NO CUTTING, NO DRILLING, NO HAMMERING.
- Use with momentary loads only, DO NOT place ladders, scaffolds, or any type of structure on the system.
- Avoid concentrated loads.
- Use only on a stable surface. Inclined surfaces, slippery surfaces and broken ground can cause injury.
- This system can be a trip hazard to pedestrian traffic if they are unaware of its presence.
- Keep the GUARD DOG cable/hose management system clean and bright.
- Load-supporting capacity varies by type of loading conditions and environmental conditions. The load capacity values are listed in the "operating parameters". The load capacity decreased in warm environments. Test before use and inspect periodically.
- Keep various services, communications, fluids and power separated. Limit a channel to one service type.
- Polyurethane is attacked by some chemicals. Always test a small amount for chemical compatibility before using and follow maintenance procedure.
- Vehicular traffic must pass over this system slowly and with caution.

MAINTENANCE

- Store in a clean dry area.
- Inspect system for damage and replace it if damaged. Remove any foreign materials, solids and liquids. Keep clean by using a detergent and water solution.

WARRANTY AND LIABILITY

LIMITED WARRANTY: Checkers guarantees the products it manufactures or sells against defects in workmanship and material for a period of one (1) year from the date of shipment or date of invoice, whichever is later. The product must be used, maintained and installed according to the instructions and procedures provided, or this warranty is void. Any alteration or modification of the product will also void this warranty. **CHECKERS' OBLIGATION UNDER THIS WARRANTY IS LIMITED TO THE REPAIR OR REPLACEMENT OF DEFECTIVE PRODUCTS.** No other warranty or remedy shall be provided. This warranty specifically does not guarantee or cover payment or reimbursement of any damages or consequential damages beyond the above.

Any claim under this warranty must be made in writing within twelve (12) months of the date of shipment or the date of invoice, whichever is later. All products returned to Checkers under this warranty must be prepaid. If it is determined that the product is defective in material and /or workmanship the repair or replacement will occur, at Checkers' option, at no charge and return freight prepaid by Checkers. All other return of product to the owner shall be at the owner's expense.

CHECKERS AND ITS AUTHORIZED AGENTS, EMPLOYEES AND REPRESENTATIVES SPECIFICALLY AND EXPRESSLY DISCLAIM ANY AND ALL OTHER WARRANTIES, INCLUDING THE WARRANTY OF FITNESS FOR A PARTICULAR PURPOSE AND/OR ANY WARRANTY OF MERCHANTABILITY WHICH MIGHT OTHERWISE BE APPLICABLE UNDER ANY STATE OR FEDERAL LAW.

LIMITED LIABILITY OF CHECKERS: Checkers and its authorized agents, distributors and representatives *do not guarantee* the performance of any Checkers product in the customer's use as the manufacturer is unable to assure proper use by the customer. Proper use by the customer is necessary for the effectiveness of the product, as well as the safety of those using same. The user is solely responsible to determine the suitability of any Checkers product for any intended use. The user assumes all risk and liability for use of any Checkers product.

User specifically acknowledges receipt of proper instructions regarding the use of the product in the original packaging and disclaims any consequential damages to person or property, damages for loss of use, lost time, loss of profit, lost income, loss of the Checkers' product itself and/or other incidental or consequential damages other than as warranted by Checkers limited warranty. User accepts the responsibility of removing from service any product that becomes worn out, unusable, unfit for intended use or defective in any way such as to make the product a potential safety hazard. Checkers is unable to undertake such obligations or responsibilities on behalf of the user as the user is in sole possession and control of the product.

© 2010 Checkers Industrial Safety Products, Inc.

CHECKERS®

INDUSTRIAL SAFETY PRODUCTS, INC.

#ZIS-GDLP1-ST
Ver: 9/10

www.checkersindustrial.com

620 COMPTON ST • BROOMFIELD, CO 80020 • PH: 720-890-1187 • FAX: 720-890-1191 • TOLL FREE: 800-438-9336